

# CREDO III

## General Information:

A directional surface mounted spotlight for ceiling mounting.

## Lamp:

12v, 35-100w G53 AR111

## Fixing Options (see separate sheet):

Jack   
M10

## Transformer Options:

Remote   
Integral within base (see separate sheet)

## Finishes:

Aluminium Grey   
White



## Dimensions:

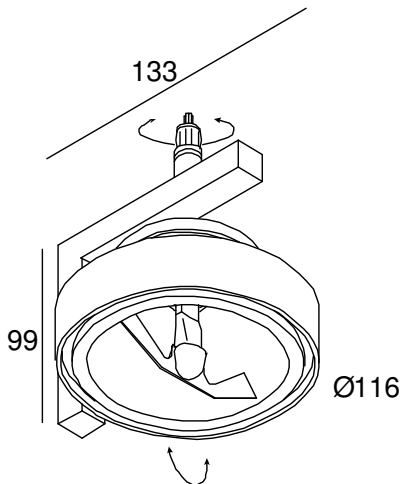

Please note that these drawings are not to scale

**LAMP AND TRANSFORMER NOT INCLUDED.**

**CAUTION:** Care should be taken with positioning of the light fitting as it will become hot in operation.

# Jackpoint Systems

## Jack point – Jack system

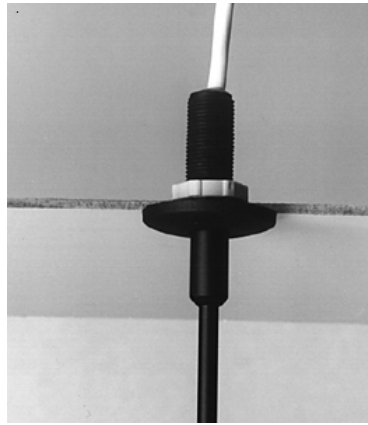
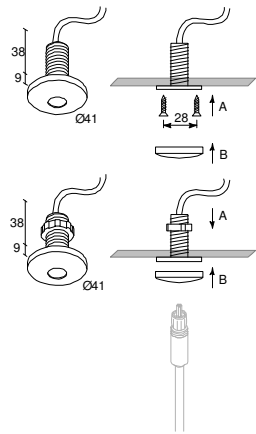

Cut out: 16mm Ø  
Recess Depth: 60mm

Finishes: Aluminium Grey  
White  
Black

## Deltapoint Single – Jack System

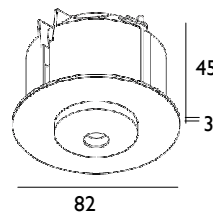

Cut out: 68mm Ø  
Recess Depth: 50mm

Finishes: Aluminium Grey  
White

## Setpoint – Jack System

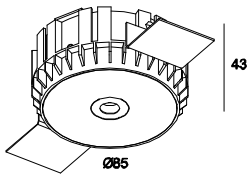

Cut out: 105mm Ø  
Recess Depth: 75mm

Finish: Prime

## Flatpoint – Jack System

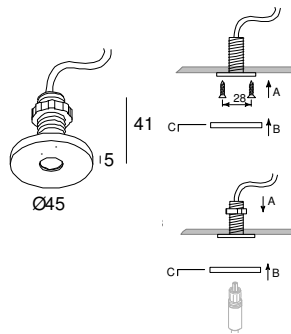

Cut out: 16mm Ø  
Recess Depth: 60mm

Finish: Aluminium

## Carreepoint – Jack system

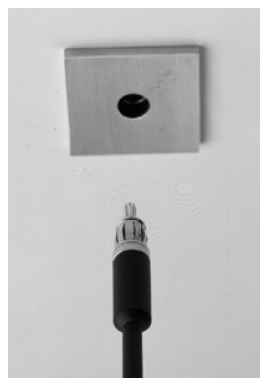
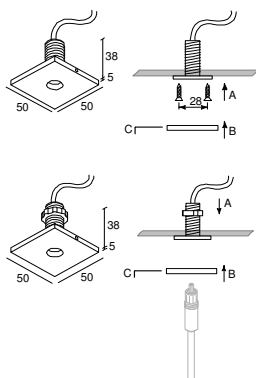

Cut out: 16mm Ø  
Recess Depth: 60mm

Finishes: Aluminium Grey  
White

## Daxpoint – Jack System

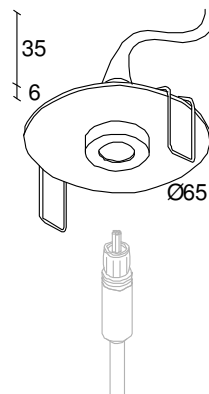

Cut out: 58mm Ø  
Recess Depth: 45mm

Finishes: Aluminium Grey  
White  
Black

# Jackpoint and M10 Systems

Sax I – Jack System

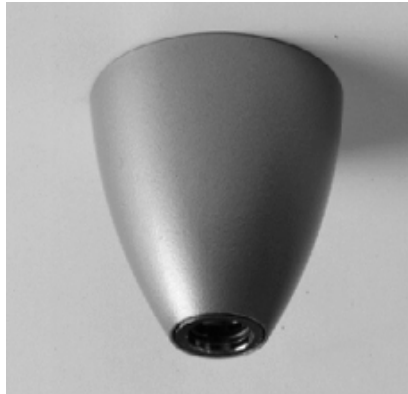
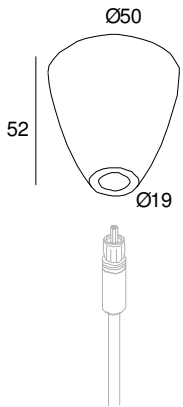

Finishes: Aluminium Grey  
White

Delta Clip – M10 System

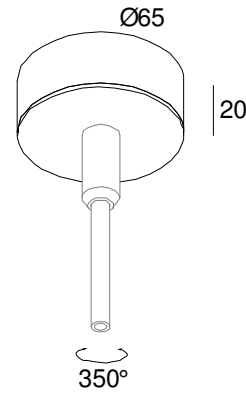

Finishes: Aluminium Grey  
White  
Black

Delta Fix – M10 System

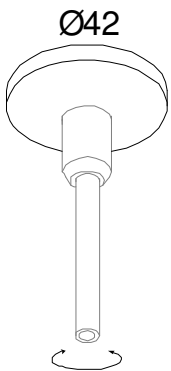

350°  
Cut out: 18mm Ø

Finishes: Aluminium Grey  
White  
Black

DaxClip – M10 System

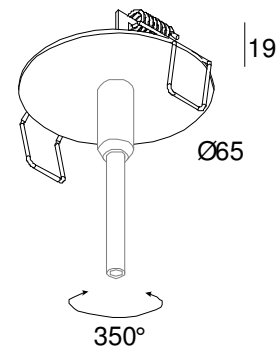

Cut out: 58mm Ø  
Recess Depth: 45mm

Finishes: Aluminium Grey  
White  
Black

# Integral Transformer Options:

Forum 1

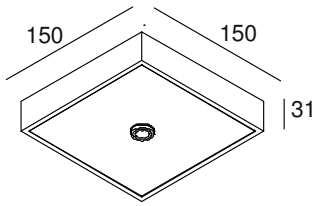

**Fitting fixing:** Jack  
35-75w  
Finishes: White or Aluminium Grey

Forum 2

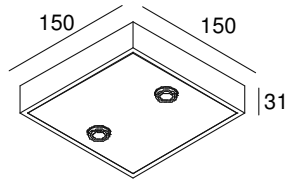

**Fitting fixing:** Jack  
2 x 20 - 50w  
Finishes: White or Aluminium Grey

Sunset 1

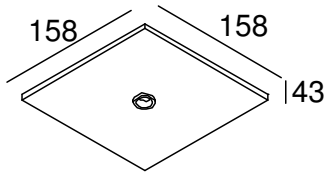

**Fitting fixing:** Jack  
20-50w  
Finishes: White or Aluminium Grey

Sunset 2

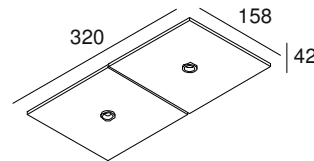

**Fitting fixing:** Jack  
2 x 20-50w  
Finishes: White or Aluminium Grey

Target 1

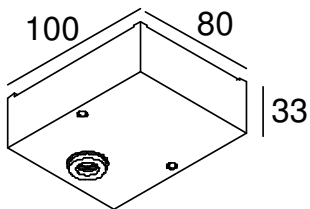

**Fitting fixing:** Jack  
20-50w  
Finishes: White or Aluminium