

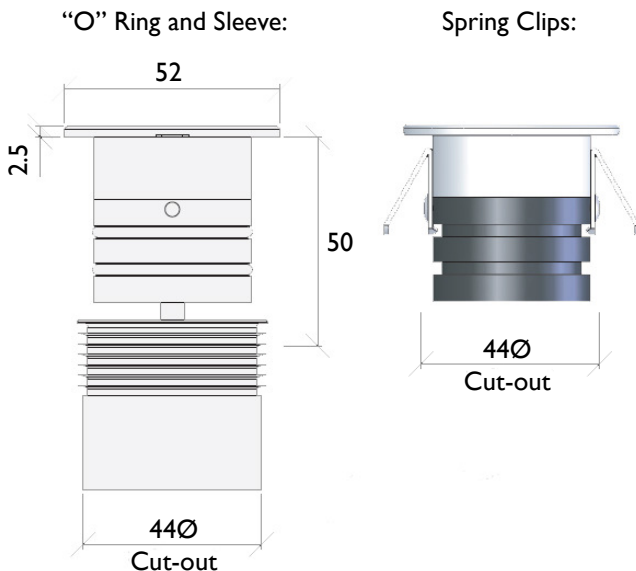

### Dimensions:



Please note that these drawings are not to scale

### DRIVER NOT INCLUDED.

**CAUTION:** Care should be taken with positioning of the light fitting as it will become hot in operation.

### General Information:

A compact design with lens set back into the fitting to reduce glare. Ideal for steplighting in both interior and exterior applications.

Installation is either by spring clips or secured by 'O' rings, with the installation sleeve, bonded into wood, concrete or aluminium plate.

### Lamp:

350mA, 1w LED

### Lamp Colour Options:

Warm White (3000k approx.)

Cold White (5000k approx.)

Red

Blue

Green

Amber

### Driver Options:

Dimmable IP20

Dimmable IP68

Non-dimmable IP20

Non-dimmable IP68

### Optics Options:

6 degree lens

15 degree lens

8 x 25 degree 'spreader' lens

### Finishes:

Powder coated white

Powder coated black

Polished Stainless steel

Stainless Steel 316

### Fixing Options:

Installation sleeve

Spring clips