

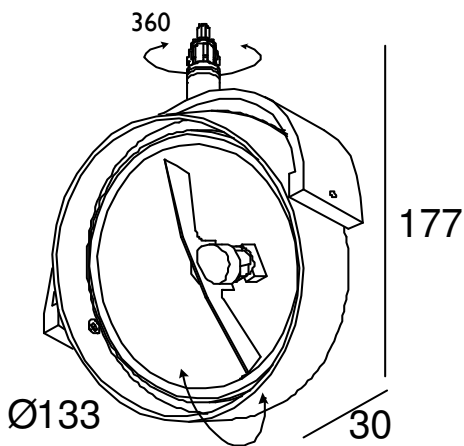

Dimensions:



Please note that these drawings are not to scale

LAMP AND TRANSFORMER NOT INCLUDED.

CAUTION: Care should be taken with positioning of the light fitting as it will become hot in operation.

General Information:

A directional surface mounted spotlight for wall or ceiling mounting.

Lamp:

12v, 35-100w G53 AR111

Fixing Options (see separate page):

Jack
M10

Transformer Options:

Remote
Integral within base (see separate page)

Finish:

Aluminium

Accessories:

Front glass + clip
Colour Filter + clip
Lens + clip

Jackpoint Systems

Jack point – Jack system

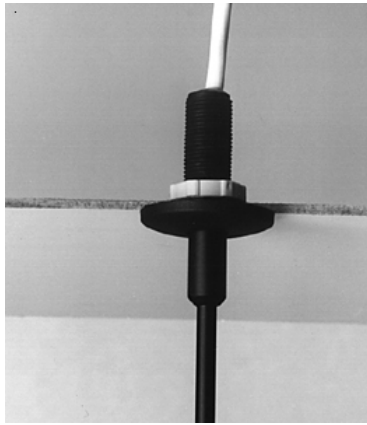
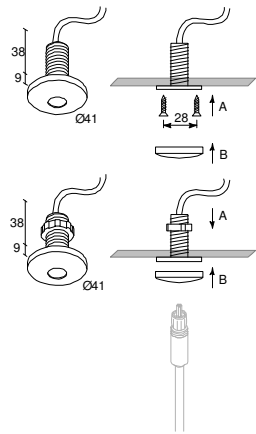

Cut out: 16mm Ø
Recess Depth: 60mm

Finishes: Aluminium Grey
White
Black

Deltapoint Single – Jack System

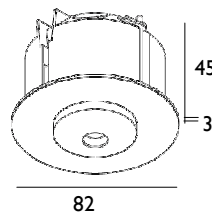

Cut out: 68mm Ø
Recess Depth: 50mm

Finishes: Aluminium Grey
White

Setpoint – Jack System

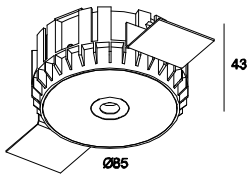

Cut out: 105mm Ø
Recess Depth: 75mm

Finish: Prime

Flatpoint – Jack System

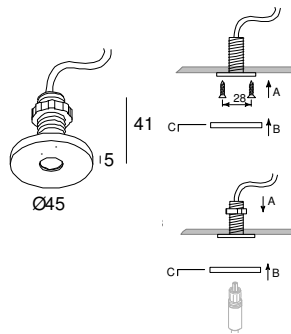

Cut out: 16mm Ø
Recess Depth: 60mm

Finish: Aluminium

Carreepoint – Jack system

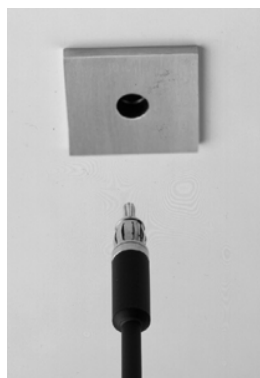
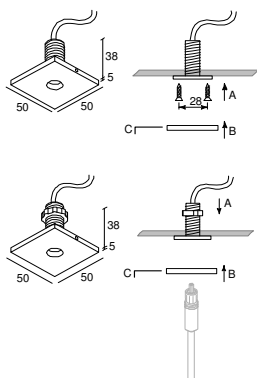

Cut out: 16mm Ø
Recess Depth: 60mm

Finishes: Aluminium Grey
White

Daxpoint – Jack System

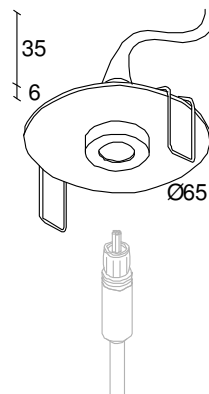

Cut out: 58mm Ø
Recess Depth: 45mm

Finishes: Aluminium Grey
White
Black

Jackpoint and M10 Systems

Sax I – Jack System

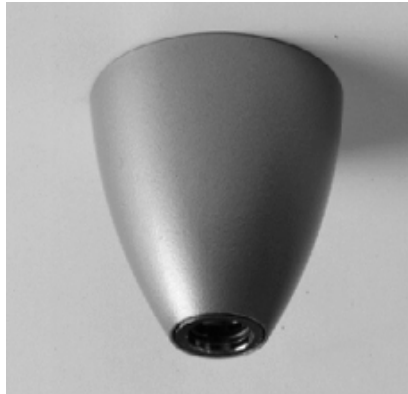
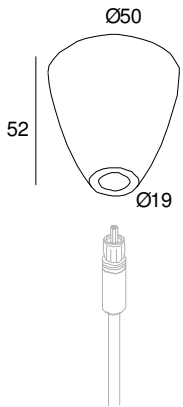

Finishes: Aluminium Grey
White

Delta Clip – M10 System

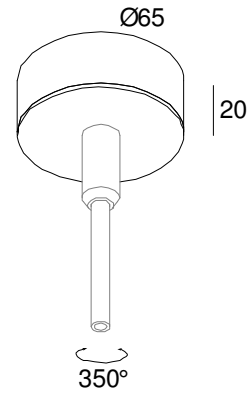

Finishes: Aluminium Grey
White
Black

Delta Fix – M10 System

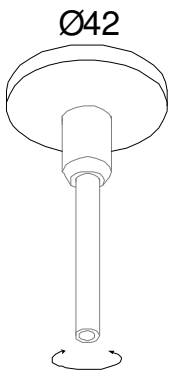

Cut out: 18mm Ø

Finishes: Aluminium Grey
White
Black

DaxClip – M10 System

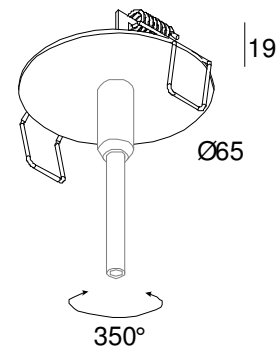

Cut out: 58mm Ø
Recess Depth: 45mm

Finishes: Aluminium Grey
White
Black

Integral Transformer Options:

Forum 1

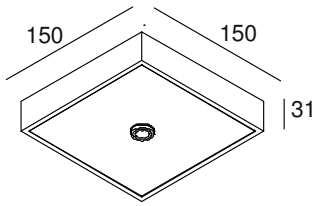

Fitting fixing: Jack
35-75w
Finishes: White or Aluminium Grey

Forum 2

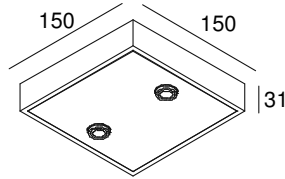

Fitting fixing: Jack
2 x 20 - 50w
Finishes: White or Aluminium Grey

Sunset 1

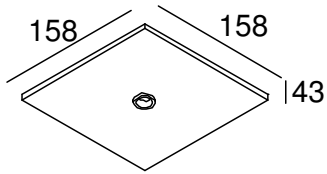

Fitting fixing: Jack
20-50w
Finishes: White or Aluminium Grey

Sunset 2

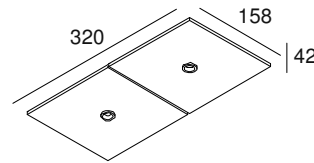

Fitting fixing: Jack
2 x 20-50w
Finishes: White or Aluminium Grey

Target 1

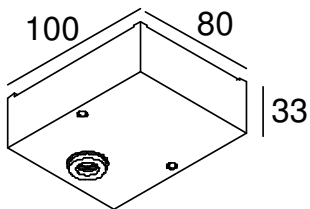

Fitting fixing: Jack
20-50w
Finishes: White or Aluminium